

Wideband Video Op Amp; Single, Single with Shutdown and Quad

General Description

The LMH6714/LMH6720/LMH6722 series combine National's VIP10™ high speed complementary bipolar process with National's current feedback topology to produce a very high speed op amp. These amplifiers provide a 400MHz small signal bandwidth at a gain of +2V/V and a 1800V/μs slew rate while consuming only 5.6mA from ±5V supplies.

The LMH6714/LMH6720/LMH6722 series offer exceptional video performance with its 0.01% and 0.01° differential gain and phase errors for NTSC and PAL video signals while driving a back terminated 75Ω load. They also offer a flat gain response of 0.1dB to 120MHz. Additionally, they can deliver 70mA continuous output current. This level of performance makes them an ideal op amp for broadcast quality video systems.

The LMH6714/LMH6720/LMH6722's small packages (SOIC, SOT23 and LLP), low power requirement, low noise and distortion allow the LMH6714/LMH6720/LMH6722 to serve portable RF applications. The high impedance state during shutdown makes the LMH6720 suitable for use in multiplexing multiple high speed signals onto a shared transmission line. The LMH6720 is also ideal for portable applications where current draw can be reduced with the shutdown function.

Features

- 400MHz ($A_V = +2V/V$, $V_{OUT} = 500mV_{PP}$) -3dB BW
- 250MHz ($A_V = +2V/V$, $V_{OUT} = 2V_{PP}$) -3dB BW
- 0.1dB gain flatness to 120MHz
- Low power: 5.6mA
- TTL compatible shutdown pin (LMH6720)
- Very low diff. gain, phase: 0.01%, 0.01° (LMH6714)
- -58 HD2/ -70 HD3 at 20MHz
- Fast slew rate: 1800V/μs
- Low shutdown current: 500uA (LMH6720)
- 11ns turn on time (LMH6720)
- 7ns shutdown time (LMH6720)
- Unity gain stable
- Improved replacement for CLC400,401,402,404,406 and 446 (LMH6714)
- Improved replacement for CLC405 (LMH6720)
- Improved replacement for CLC415 (LMH6722)
- LMH6722QSD is AEC-Q100 grade 1 qualified and is manufactured on an automotive grade flow

Applications

- HDTV, NTSC & PAL video systems
- Video switching and distribution
- Wideband active filters
- Cable drivers
- High speed multiplexer (LMH6720)
- Programmable gain amplifier (LMH6720)
- Automotive (LMH6722)

Typical Performance

Non-Inverting Small Signal Frequency Response

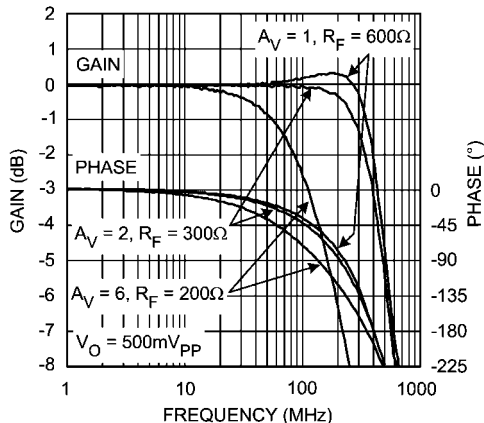

20056506

Differential Gain and Phase vs. Number of Video Loads (LMH6714)

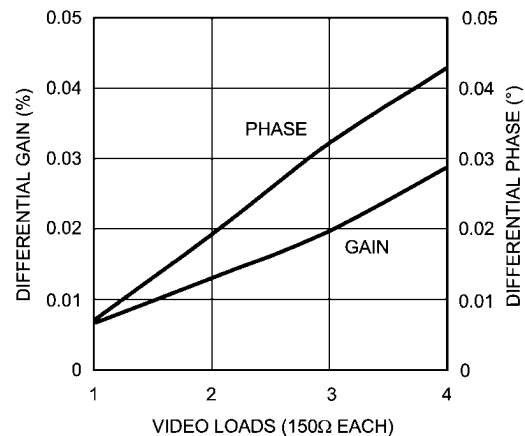

20056528

Absolute Maximum Ratings *(Note 1)*

If Military/Aerospace specified devices are required, please contact the National Semiconductor Sales Office/Distributors for availability and specifications.

ESD Tolerance <i>(Note 4)</i>	
Human Body Model	2000V
Machine Model	200V
V_{CC}	$\pm 6.75V$
I_{OUT}	<i>(Note 3)</i>
Common Mode Input Voltage	$\pm V_{CC}$
Differential Input Voltage	2.2V
Maximum Junction Temperature	+150°C
Storage Temperature Range	-65°C to +150°C
Lead Temperature (soldering 10 sec)	+300°C

Storage Temperature Range	-65°C to +150°C
Shutdown Pin Voltage <i>(Note 5)</i>	$+V_{CC}$ to $V_{CC}/2-1V$

Operating Ratings *(Note 1)*

Thermal Resistance	
Package	(θ_{JA})
5-Pin SOT23	232°C/W
6-Pin SOT23	198°C/W
8-Pin SOIC	145°C/W
14-Pin SOIC	130°C/W
14-Pin TSSOP	160°C/W
14-Pin LLP	46°C/W
Operating Temperature	-40°C to 85°C
Operating Temperature LLP	-40°C to 125°C
Supply Voltage Range	8V ($\pm 4V$) to 12.5V ($\pm 6.25V$)

Electrical Characteristics

Unless specified, $A_V = +2$, $R_F = 300\Omega$; $V_{CC} = \pm 5V$, $R_L = 100\Omega$, LMH6714/LMH6720/LMH6722. **Boldface** limits apply at temperature extremes.

Symbol	Parameter	Conditions	Min <i>(Note 7)</i>	Typ <i>(Note 6)</i>	Max <i>(Note 7)</i>	Units
Frequency Domain Response						
SSBW	-3dB Bandwidth	$V_{OUT} = 0.5V_{PP}$	345	400		MHz
LSBW	-3dB Bandwidth	$V_{OUT} = 2.0V_{PP}$	200	250		MHz
LSBW	-3dB Bandwidth, LMH6722 TSSOP package only	$V_{OUT} = 2.0V_{PP}$	170	250		MHz
	Gain Flatness	$V_{OUT} = 2V_{PP}$				
GFP	Peaking	DC to 120MHz		0.1		dB
GFR	Rolloff	DC to 120MHz		0.1		dB
LPD	Linear Phase Deviation	DC to 120MHz		0.5		deg
DG	Differential Gain	$R_L = 150\Omega$, 4.43MHz (LMH6714)		0.01		%
DG	Differential Gain	$R_L = 150\Omega$, 4.43MHz (LMH6720)		0.02		%
DP	Differential Phase	$R_L = 150\Omega$, 4.43MHz		0.01		deg
Time Domain Response						
TRS	Rise and Fall Time	.5V Step		1.5		ns
TRL		2V Step		2.6		ns
t_s	Settling Time to 0.05%	2V Step		12		ns
SR	Slew Rate	6V Step	1200	1800		V/ μ s
Distortion and Noise Response						
HD2	2nd Harmonic Distortion	$2V_{PP}$, 20MHz		-58		dBc
HD3	3rd Harmonic Distortion	$2V_{PP}$, 20MHz		-70		dBc
IMD	3rd Order Intermodulation Products	10MHz, $P_{OUT} = 0dBm$		-78		dBc
	Equivalent Input Noise					
VN	Non-Inverting Voltage	>1MHz		3.4		nV/ \sqrt{Hz}
NICN	Inverting Current	>1MHz		10		pA/ \sqrt{Hz}
ICN	Non-Inverting Current	>1MHz		1.2		pA/ \sqrt{Hz}
Static, DC Performance						
V_{IO}	Input Offset Voltage			± 0.2	± 6 ± 8	mV
DVIO	Average Drift			8		μ V/°C

Symbol	Parameter	Conditions		Min (Note 7)	Typ (Note 6)	Max (Note 7)	Units
I_{BN}	Input Bias Current	Non-Inverting			±1	±10 ±15	µA
DIBN	Average Drift				4		nA/°C
I_{BI}	Input Bias Current	Inverting			-4	±12 ±20	µA
DIBI	Average Drift				41		nA/°C
PSRR	Power Supply Rejection Ratio	DC		48 47	58		dB
CMRR	Common Mode Rejection Ratio	DC		48 45	54		dB
I_{CC}	Supply Current	$R_L = \infty$	LMH6714	4.5	5.6	7.5	mA
			LMH6720	3		8	
			LMH6722	18 15	22.5	30 32	
I_{CCI}	Supply Current During Shutdown	LMH6720			500	670	µA
Miscellaneous Performance							
R_{IN}	Input Resistance	Non-Inverting			2		MΩ
C_{IN}	Input Capacitance	Non-Inverting			1.0		pF
R_{OUT}	Output Resistance	Closed Loop			0.06		Ω
V_{OUT}	Output Voltage Range	$R_L = \infty$		±3.5 ±3.4	±3.9		V
		$R_L = 100\Omega$		±3.6 ±3.4	±3.8		
CMIR	Input Voltage Range	Common Mode			±2.2		V
I_{OUT}	Output Current (Note 3)	$V_{IN} = 0V$, Max Linear Current		50	70		mA
OFFMAX	Voltage for Shutdown	LMH6720				0.8	V
ONMIN	Voltage for Turn On	LMH6720		2.0			V
IIH	Current Turn On	LMH6720, $\overline{SD} = 2.0V$		-20 -30	2	20 30	µA
IIL	Current Shutdown	LMH6720, $\overline{SD} = .8V$		-600	-400	-100	µA
IOZ	R_{OUT} Shutdown	LMH6720, $\overline{SD} = .8V$		0.2	1.8		MΩ
t_{on}	Turn on Time	LMH6720			11		ns
t_{off}	Turn off Time	LMH6720			7		ns

Note 1: Absolute Maximum Ratings indicate limits beyond which damage to the device may occur. Operating Ratings indicate conditions for which the device is intended to be functional, but specific performance is not guaranteed. For guaranteed specifications, see the Electrical Characteristics tables.

Note 2: Electrical Table values apply only for factory testing conditions at the temperature indicated. Factory testing conditions result in very limited self-heating of the device such that $T_J = T_A$. No guarantee of parametric performance is indicated in the electrical tables under conditions of internal self heating where $T_J > T_A$. See Applications Section for information on temperature derating of this device." Min/Max ratings are based on product characterization and simulation. Individual parameters are tested as noted.

Note 3: The maximum output current (I_{OUT}) is determined by device power dissipation limitations. See the Power Dissipation section of the Application Division for more details.

Note 4: Human Body Model, applicable std. MIL-STD-883, Method 3015.7. Machine Model, applicable std. JESD22-A115-A (ESD MM std. of JEDEC) Field-Induced Charge-Device Model, applicable std. JESD22-C101-C (ESD FICDM std. of JEDEC).

Note 5: The shutdown pin is designed to work between 0 and V_{CC} with split supplies ($V_{CC} = -V_{EE}$). With single supplies ($V_{EE} = \text{ground}$) the shutdown pin should not be taken below $V_{CC}/2$.

Note 6: Typical values represent the most likely parametric norm at the time of characterization. Actual typical values may vary over time and will also depend on the application and configuration. The typical values are not tested and are not guaranteed on shipped production material.

Note 7: All limits are guaranteed by testing, design, or statistical analysis.

Connection Diagrams

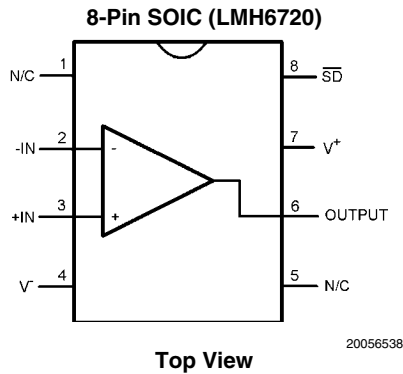
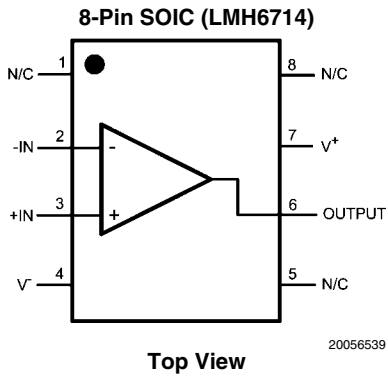
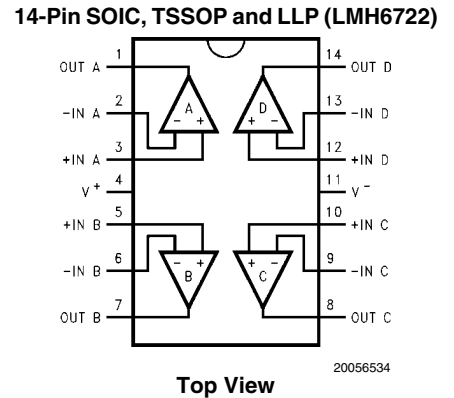
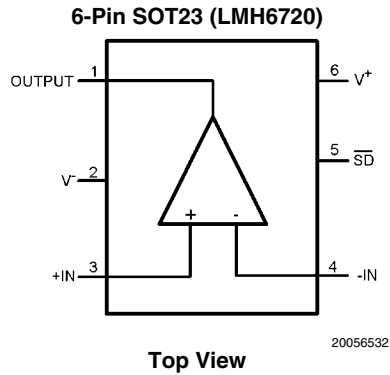
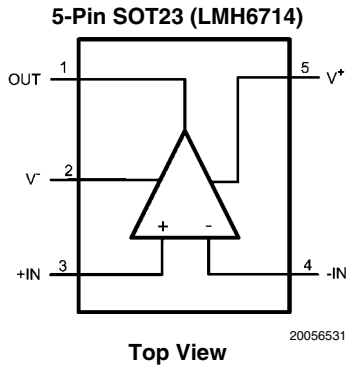

Ordering Information

Package	Part Number	Package Marking	Transport Media	NSC Drawing	Features
5-Pin SOT23	LMH6714MF	A95A	1k Units Tape and Reel	MF05A	
	LMH6714MFX		3k Units Tape and Reel		
8-Pin SOIC	LMH6714MA	LMH6714MA	95 Units / Rail	M08A	
	LMH6714MAX		2.5k Units Tape and Reel		
6-Pin SOT23	LMH6720MF	A96A	1k Units Tape and Reel	MF06A	
	LMH6720MFX		3k Units Tape and Reel		
8-Pin SOIC	LMH6720MA	LMH6720MA	95 Units / Rail	M08A	
	LMH6720MAX		2.5k Units Tape and Reel		
14-Pin SOIC	LMH6722MA	LMH6722MA	55 Units / Rail	M14A	
	LMH6722MAX		2.5k Units Tape and Reel		
14-Pin TSSOP	LMH6722MT	LMH6722MT	94 Units / Rail	MTC14	
	LMH6722MTX		2.5k Units Tape and Reel		
14-Pin LLP	LMH6722SD	L6722	1k Units Tape and Reel	SDA14A	AEC-Q100 Grade 1 qualified. Automotive Grade Production Flow**
	LMH6722SDX		4.5k Units Tape and Reel		
	LMH6722QSD	L6722Q	1k Units Tape and Reel		
	LMH6722QSDX		4.5k Units Tape and Reel		

**Automotive Grade (Q) product incorporates enhanced manufacturing and support processes for the automotive market, including defect detection methodologies. Reliability qualification is compliant with the requirements and temperature grades defined in the AEC-Q100 standard. Automotive grade products are identified with the letter Q. For more information go to <http://www.national.com/automotive>.

Typical Performance Characteristics

Specified).

($V^+ = +5V$, $V^- = -5V$, $A_V = 2$, $R_F = 300\Omega$, $R_L = 100\Omega$ Unless

LMH6714/ LMH6720/ LMH6722/ LMH6722Q

Non-Inverting Small Signal Frequency Response

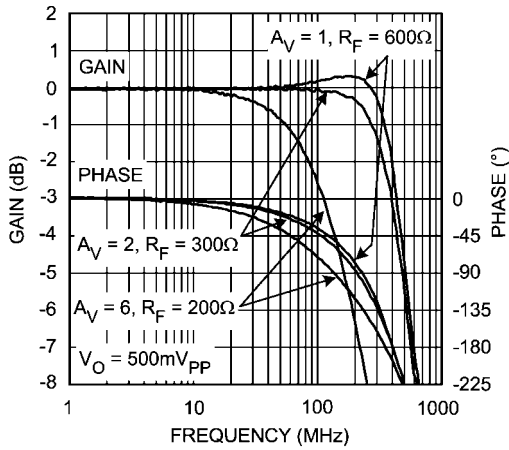

20056506

Non-Inverting Large Signal Frequency Response

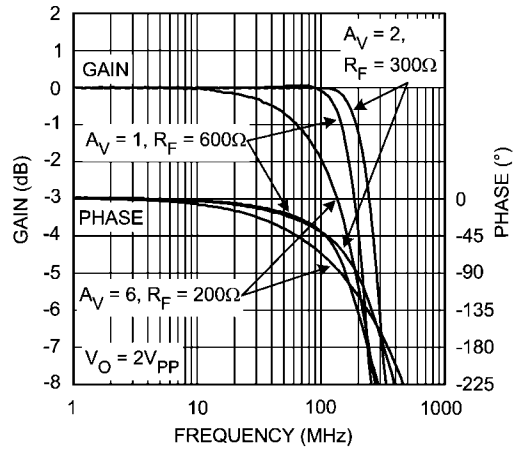

20056507

Inverting Frequency Response

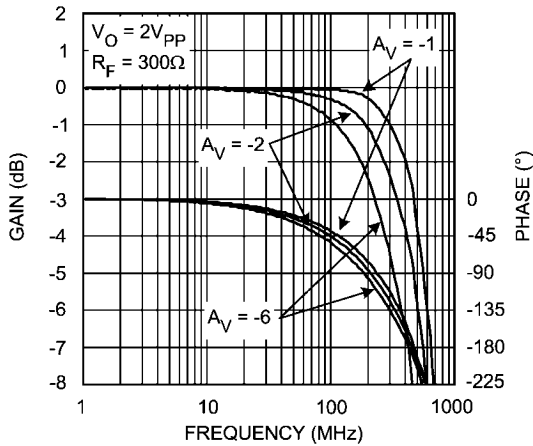

20056503

Non-Inverting Frequency Response vs. V_O

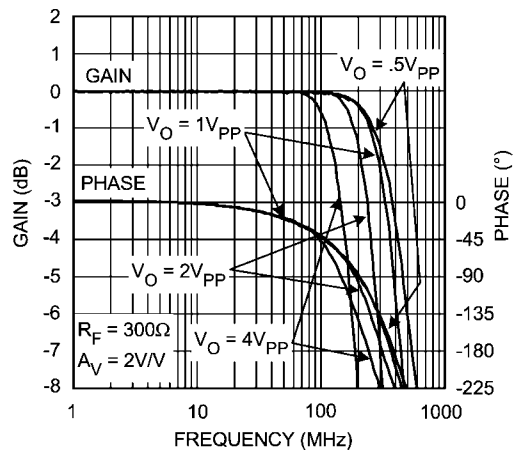

20056508

Inverting Frequency Response vs. V_O

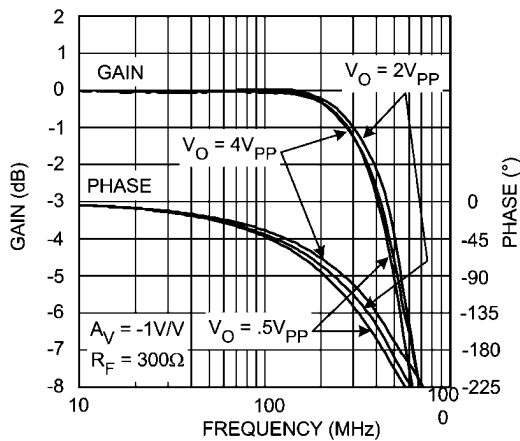

20056509

Harmonic Distortion vs. Frequency

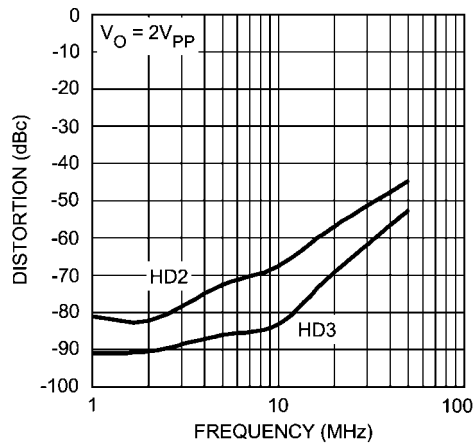

20056504

2nd Harmonic Distortion vs. V_{OUT}

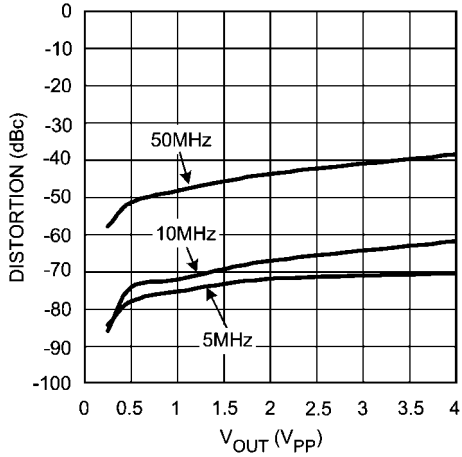

20056502

3rd Harmonic Distortion vs. V_{OUT}

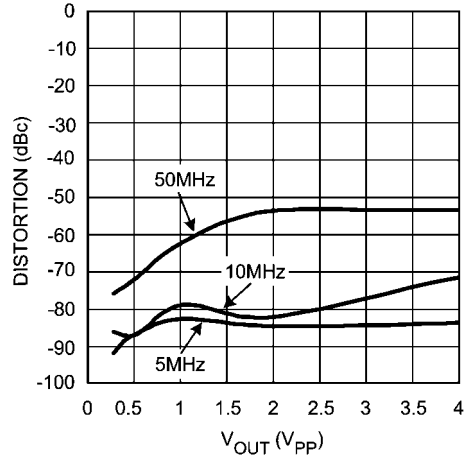

20056501

DG/DP (LMH6714)

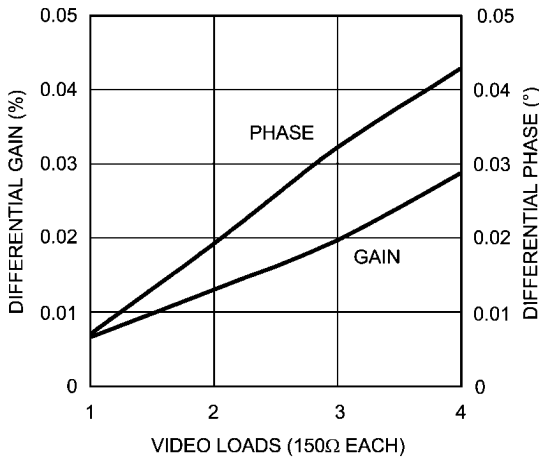

20056528

DG/DP (LMH6720)

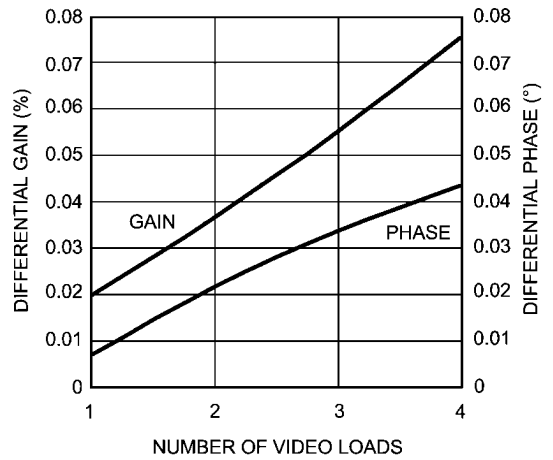

20056505

DG/DP (LMH6722)

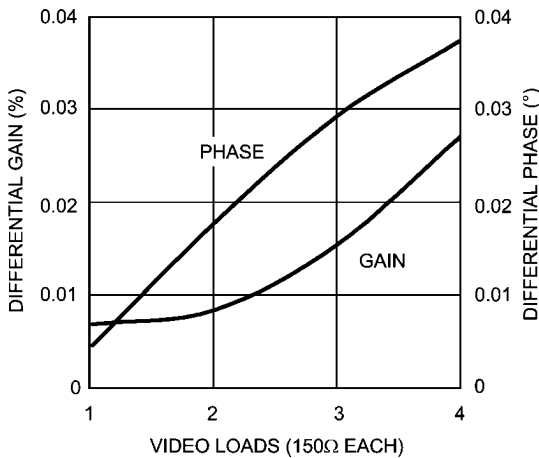

20056535

Large Signal Pulse Response

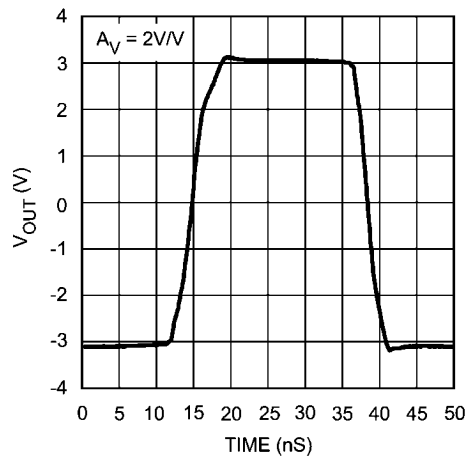

20056513

Small Signal Pulse Response

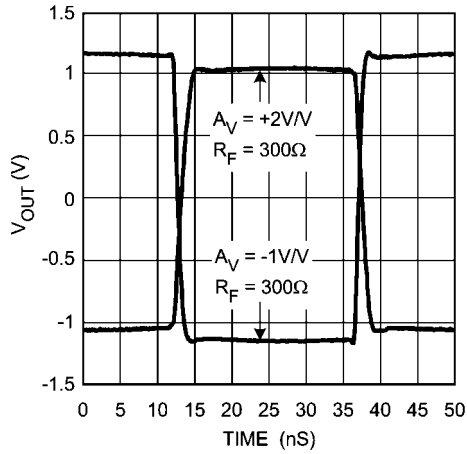

20056510

Closed Loop Output Resistance

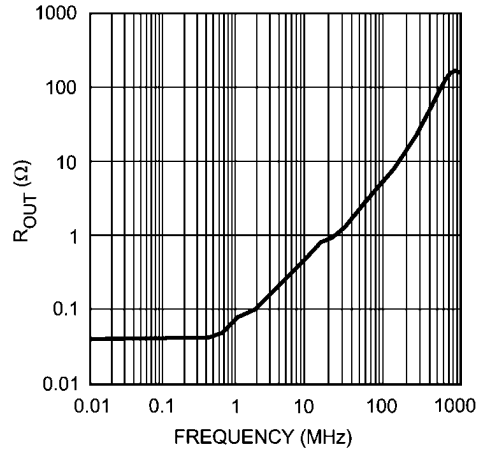

20056511

Open Loop Transimpedance Z(s)

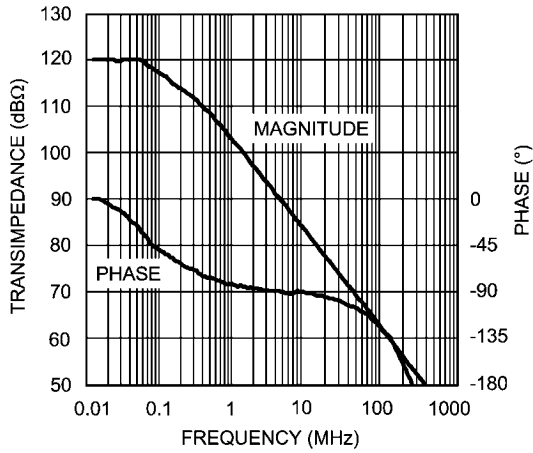

20056523

PSRR vs. Frequency

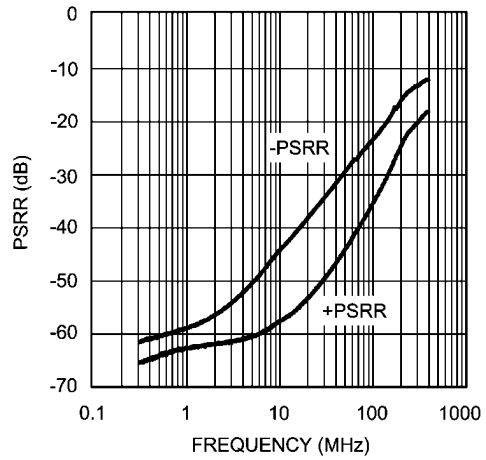

20056516

CMRR vs. Frequency

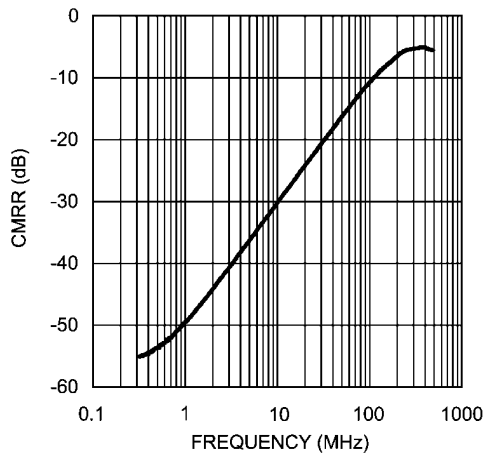

20056525

Frequency Response vs. R_F

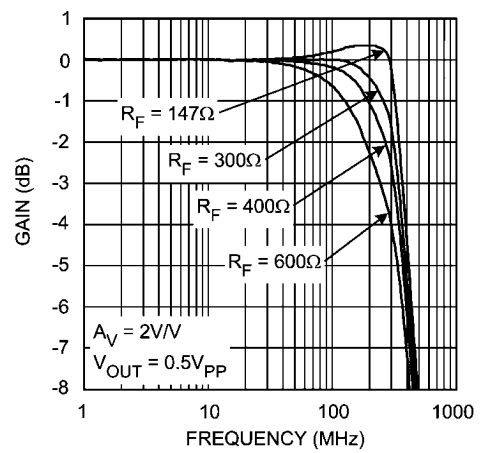

20056512

DC Errors vs. Temperature

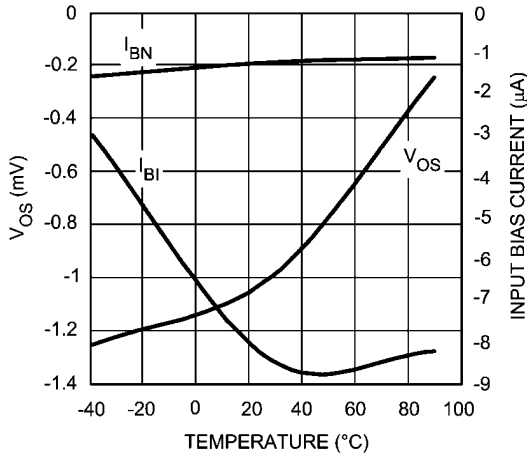

20056518

Maximum V_{OUT} vs. Frequency

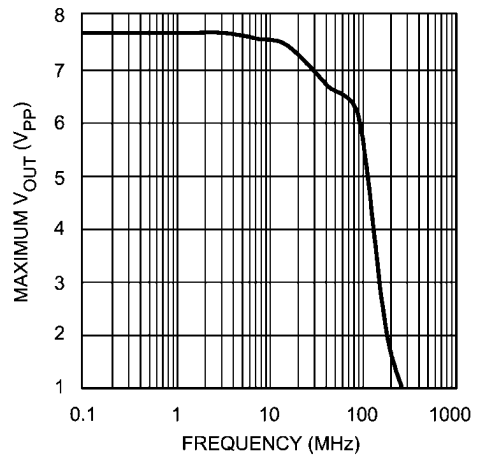

20056526

3rd Order Intermodulation vs. Output Power

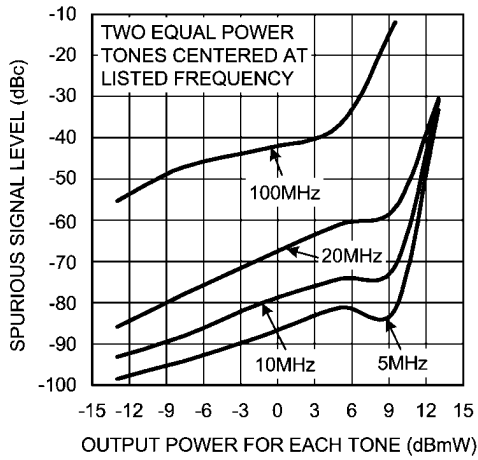

20056527

Crosstalk vs. Frequency (LMH6722) for each channel with all others active

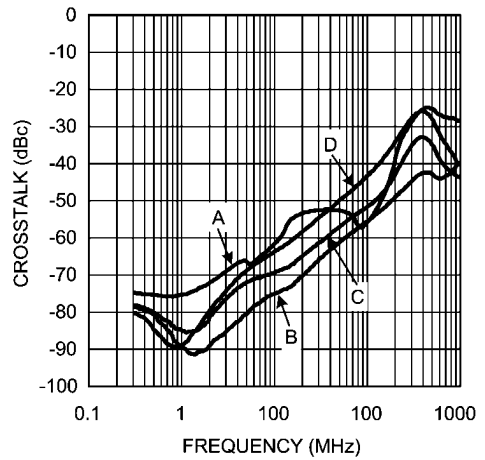

20056536

Noise vs. Frequency

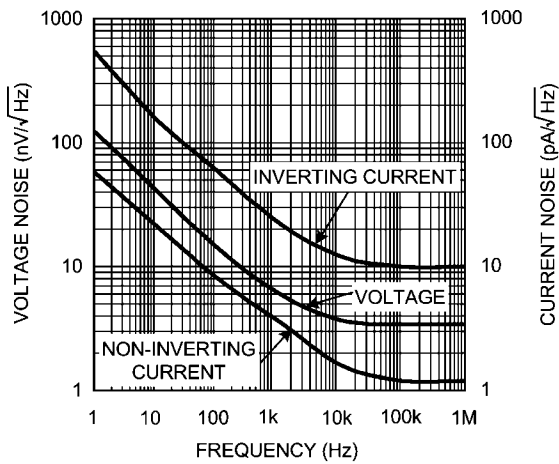

20056540

Application Section

FEEDBACK RESISTOR SELECTION

One of the key benefits of a current feedback operational amplifier is the ability to maintain optimum frequency response independent of gain by using appropriate values for the feedback resistor (R_F). The Electrical Characteristics and Typical Performance plots specify an R_F of 300Ω , a gain of $+2V/V$ and $\pm 5V$ power supplies (unless otherwise specified). Generally, lowering R_F from its recommended value will peak the frequency response and extend the bandwidth while increasing the value of R_F will cause the frequency response to roll off faster. Reducing the value of R_F too far below its recommended value will cause overshoot, ringing and, eventually, oscillation.

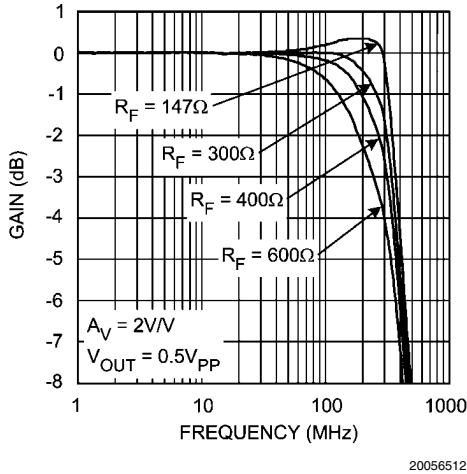

FIGURE 1. Frequency Response vs. R_F

The plot labeled "Frequency Response vs. R_F " shows the LMH6714/LMH6720/LMH6722's frequency response as R_F is varied ($R_L = 100\Omega$, $A_V = +2$). This plot shows that an R_F of 147Ω results in peaking. An R_F of 300Ω gives near maximal bandwidth and gain flatness with good stability. An R_F of 400Ω gives excellent stability with only a small bandwidth penalty. Since all applications are slightly different it is worth some experimentation to find the optimal R_F for a given circuit. Note that it is not possible to use a current feedback amplifier with the output shorted directly to the inverting input. The buffer configuration of the LMH6714/LMH6720/LMH6722 requires a 600Ω feedback resistor for stable operation.

For more information see Application Note OA-13 which describes the relationship between R_F and closed-loop frequency response for current feedback operational amplifiers. The value for the inverting input impedance for the LMH6714/LMH6720/LMH6722 is approximately 180Ω . The LMH6714/LMH6720/LMH6722 is designed for optimum performance at gains of $+1$ to $+6 V/V$ and -1 to $-5V/V$. When using gains of $\pm 7V/V$ or more the low values of R_G required will make inverting input impedances very low.

When configuring the LMH6714/LMH6720/LMH6722 for gains other than $+2V/V$, it is usually necessary to adjust the value of the feedback resistor. The two plots labeled " R_F vs. Non-inverting Gain" and " R_F vs. Inverting Gain" provide recommended feedback resistor values for a number of gain selections.

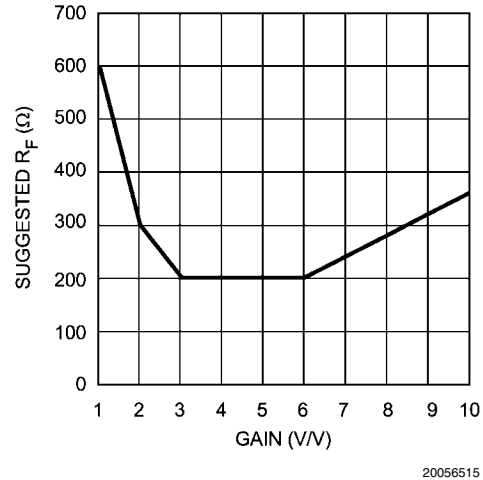

FIGURE 2. R_F vs. Non-Inverting Gain

In the " R_F vs. Non-Inverting Gain" and the " R_F vs. Inverting Gain" charts the recommended value of R_F is depicted by the solid line, which starts high, decreases to 200Ω and begins increasing again. The reason that a higher R_F is required at higher gains is the need to keep R_G from decreasing too far below the output impedance of the input buffer. For the LMH6714/LMH6720/LMH6722 the output resistance of the input buffer is approximately 180Ω and 50Ω is a practical lower limit for R_G . Due to the limitations on R_G the LMH6714/LMH6720/LMH6722 begins to operate in a gain bandwidth limited fashion for gains of $\pm 5V/V$ or greater.

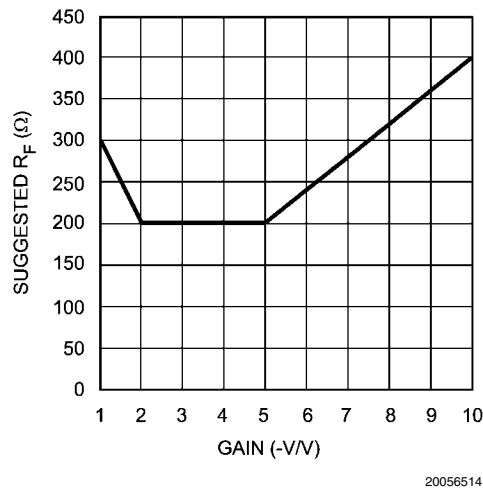

FIGURE 3. R_F vs. Inverting Gain

ACTIVE FILTERS

When using any current feedback Operational Amplifier as an active filter it is important to be very careful when using reactive components in the feedback loop. Anything that reduces the impedance of the negative feedback, especially at higher frequencies, will almost certainly cause stability problems. Likewise capacitance on the inverting input needs to be avoided. See Application Notes OA-7 and OA-26 for more information on Active Filter applications for Current Feedback Op Amps.

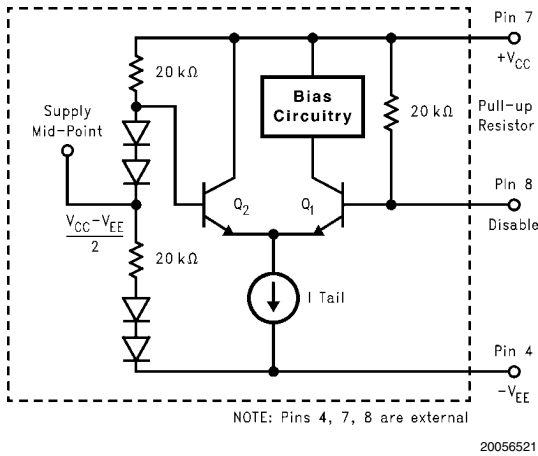

FIGURE 4. Enable/Disable Operation

ENABLE/DISABLE OPERATION USING ±5V SUPPLIES (LMH6720 ONLY)

The LMH6720 has a TTL logic compatible disable function. Apply a logic low (<.8V) to the DS pin and the LMH6720 is disabled. Apply a logic high (>.20V), or let the pin float and the LMH6720 is enabled. Voltage, not current, at the Disable pin determines the enable/disable state. Care must be exercised to prevent the disable pin voltage from going more than .8V below the midpoint of the supply voltages (0V with split supplies, $V_{CC}/2$ with single supplies) doing so could cause transistor Q1 to Zener resulting in damage to the disable circuit. The core amplifier is unaffected by this, but disable operation could become slower as a result.

Disabled, the LMH6720 inputs and output become high impedances. While disabled the LMH6720 quiescent current is approximately 500µA. Because of the pull up resistor on the disable circuit the I_{CC} and I_{EE} currents are not balanced in the disabled state. The positive supply current (I_{CC}) is approximately 500µA while the negative supply current (I_{EE}) is only 200µA. The remaining I_{EE} current of 300µA flows through the disable pin.

The disable function can be used to create analog switches or multiplexers. Implement a single analog switch with one LMH6720 positioned between an input and output. Create an analog multiplexer with several LMH6720's. The LMH6720 is at it's best at a gain of 1 for multiplexer applications because there is no R_G to shunt signals to ground.

DISABLE LIMITATIONS (LMH6720 ONLY)

The feedback Resistor (R_F) limits off isolation in inverting gain configurations. During shutdown the impedance of the LMH6720 inputs and output become very high (>1MΩ), however R_F and R_G are the dominant factor for effective output impedance.

Do not apply voltages greater than $+V_{CC}$ or less than 0V ($V_{CC}/2$ single supply) to the disable pin. The input ESD diodes will also conduct if the signal leakage through the feedback resistors brings the inverting input near either supply rail.

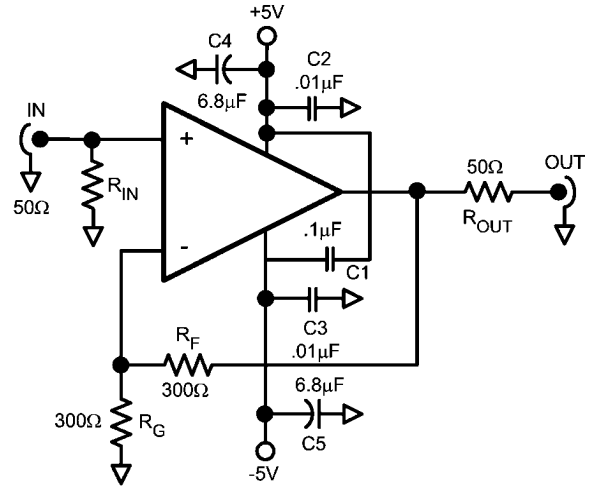

FIGURE 5. Typical Application with Suggested Supply Bypassing

LAYOUT CONSIDERATIONS

Whenever questions about layout arise, use the evaluation board as a guide. The following Evaluation boards are available with sample parts:

LMH6714	SOT	CLC730216
	SOIC	CLC730227
LMH6720	SOT	CLC730216
	SOIC	CLC730227
LMH6722	SOIC	CLC730231

To reduce parasitic capacitances, the ground plane should be removed near the input and output pins. To reduce series inductance, trace lengths of components in the feedback loop should be minimized. For long signal paths controlled impedance lines should be used, along with impedance matching at both ends.

Bypass capacitors should be placed as close to the device as possible. Bypass capacitors from each rail to ground are applied in pairs. The larger electrolytic bypass capacitors can be located anywhere on the board, the smaller ceramic capacitors should be placed as close to the device as possible. In addition Figure 2 shows a capacitor (C1) across the supplies with no connection to ground. This capacitor is optional, however it is required for best 2nd Harmonic suppression. If this capacitor is omitted C2 and C3 should be increased to .1µF each.

VIDEO PERFORMANCE

The LMH6714/LMH6720/LMH6722 has been designed to provide excellent performance with both PAL and NTSC composite video signals. Performance degrades as the loading is increased, therefore best performance will be obtained with back terminated loads. The back termination reduces reflections from the transmission line and effectively masks capacitance from the amplifier output stage. While all parts offer excellent video performance the LMH6714 and LMH6722 are slightly better than the LMH6720.

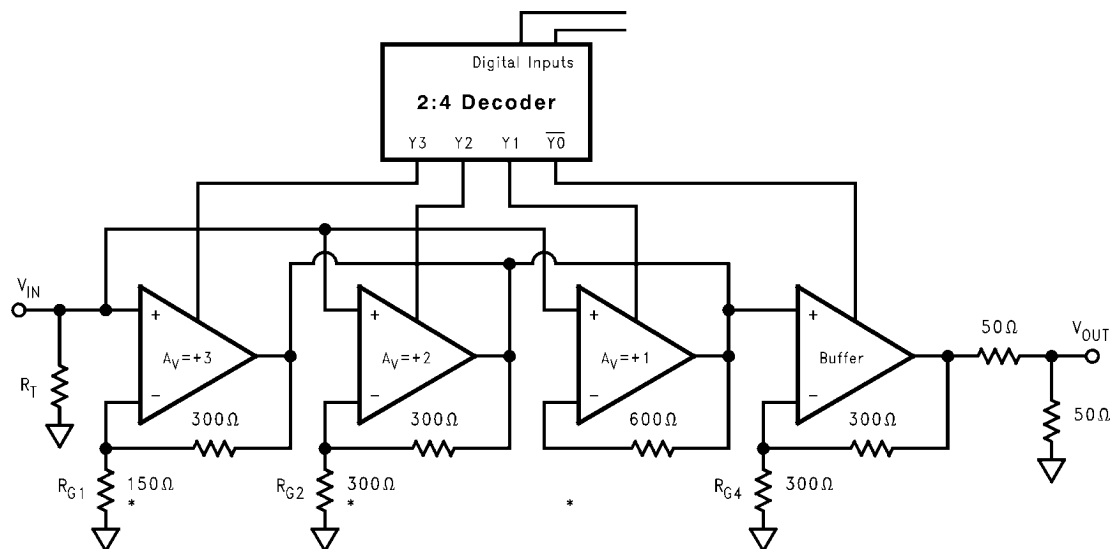

*NOTE: Selectable gains can be changed by using different R_g resistors.

20056519

FIGURE 6. Wideband Digitally Controlled Programmable Gain Amplifier

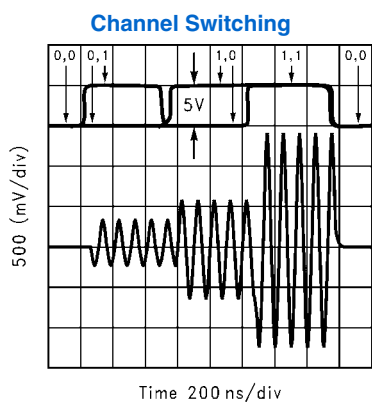

20056520

FIGURE 7. PGA Output

As shown in [Figure 6](#) and [Figure 7](#) the LMH6720 can be used to construct a digitally controlled programmable gain amplifier. Each amplifier is configured to provide a digitally selectable gain. To provide for accurate gain settings, 1% or **AMPLITUDE EQUALIZATION**

Sending signals over coaxial cable greater than 50 meters in length will attenuate high frequency signal components much more than lower frequency components. An equalizer can be made to pre emphasize the higher frequency components so that the final signal has less distortion. This process can be done at either end of the cable. The circuit in [Figure 8](#) shows a receiver with some additional components in the feedback loop to equalize the incoming signal. The RC networks peak the signal at higher frequencies. This peaking is a piecewise linear approximation of the inverse of the frequency response of the coaxial cable. [Figure 9](#) shows the effect of this equalization on a digital signal that has passed through 150 meters of coaxial cable. [Figure 10](#) shows a Bode plot of the frequency

better tolerance is recommended on the feedback and gain resistors. The gain provided by each digital code is arbitrary through selection of the feedback and gain resistor values.

response of the circuit in [Figure 8](#) along with equations needed to design the pole and zero frequencies. [Figure 11](#) shows a network analyzer plot of an LMH6714/LMH6720/LMH6722 with the following component values:

- $R_G = 309\Omega$
- $R1 = 450\Omega$
- $C1 = 470\text{pF}$
- $R2 = 91\Omega$
- $C2 = 68\text{pF}$

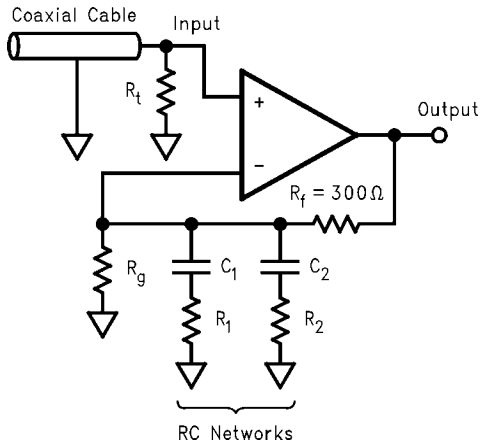

20056522

FIGURE 8. Equalizer Circuit Schematic

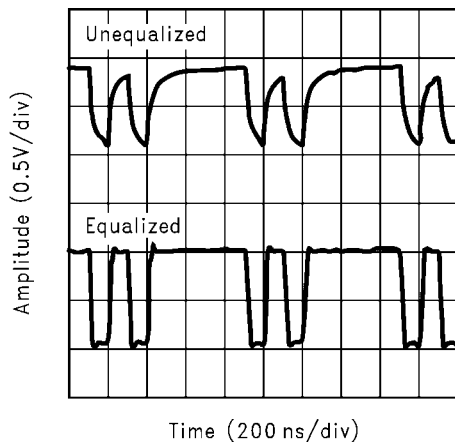

20056529

FIGURE 9. Digital Signal without and with Equalization

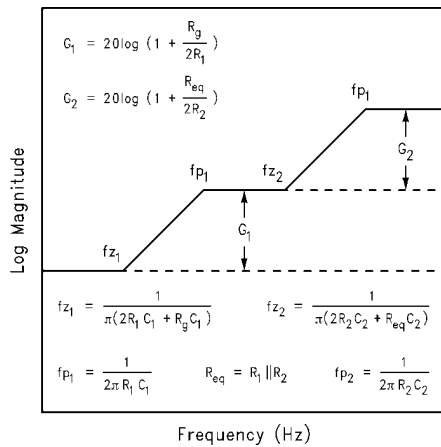

20056530

FIGURE 10. Design Equations

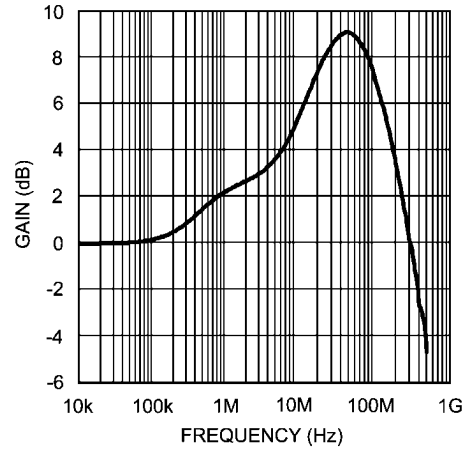

20056517

FIGURE 11. Equalizer Frequency Response

POWER DISSIPATION

Follow these steps to determine the Maximum power dissipation for the LMH6714/LMH6720/LMH6722:

1. Calculate the quiescent (no load) power: $P_{AMP} = I_{CC} (V_{CC} - V_{EE})$
2. Calculate the RMS power at the output stage: $P_{OUT} (RMS) = (V_{CC} - V_{OUT} (RMS)) * I_{OUT} (RMS)$, where V_{OUT} and I_{OUT} are the voltage and current across the external load.
3. Calculate the total RMS power: $P_T = P_{AMP} + P_{OUT}$

The maximum power that the LMH6714/LMH6720/LMH6722, package can dissipate at a given temperature can be derived with the following equation:

$P_{MAX} = (150^\circ - T_A) / \theta_{JA}$, where T_A = Ambient temperature ($^\circ C$) and θ_{JA} = Thermal resistance, from junction to ambient, for a given package ($^\circ C/W$). For the SOIC package θ_{JA} is $148^\circ C/W$, for the SOT it is $250^\circ C/W$.

Physical Dimensions inches (millimeters) unless otherwise noted

LMH6714/ LMH6720/ LMH6722/ LMH6722Q

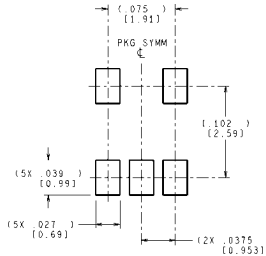
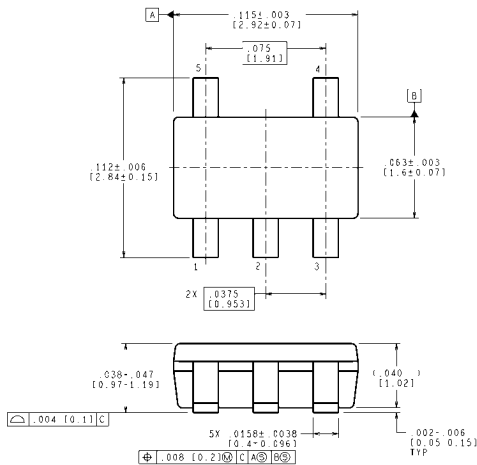

LAND PATTERN RECOMMENDATION

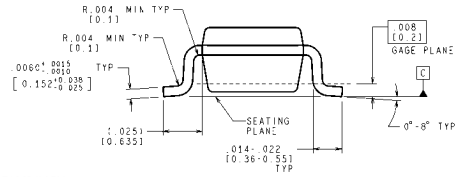

CONTROLLING DIMENSION IS INCH
VALUES IN [] ARE MILLIMETERS
DIMENSIONS IN () FOR REFERENCE ONLY

MF05A (Rev D)

5-Pin SOT23
NS Product Number MF05A

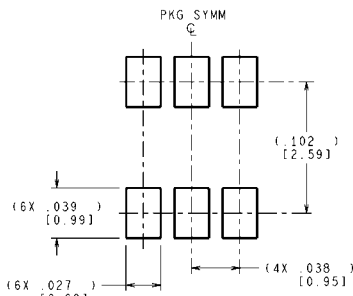
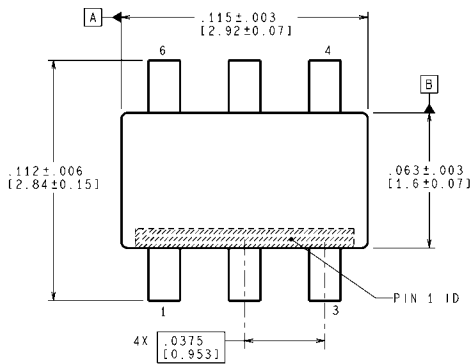

RECOMMENDED LAND PATTERN

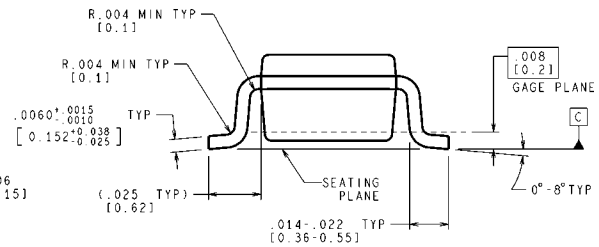

CONTROLLING DIMENSION IS INCH
VALUES IN [] ARE MILLIMETERS
DIMENSIONS IN () FOR REFERENCE ONLY

MF06A (Rev C)

6-Pin SOT23
NS Product Number MF06A

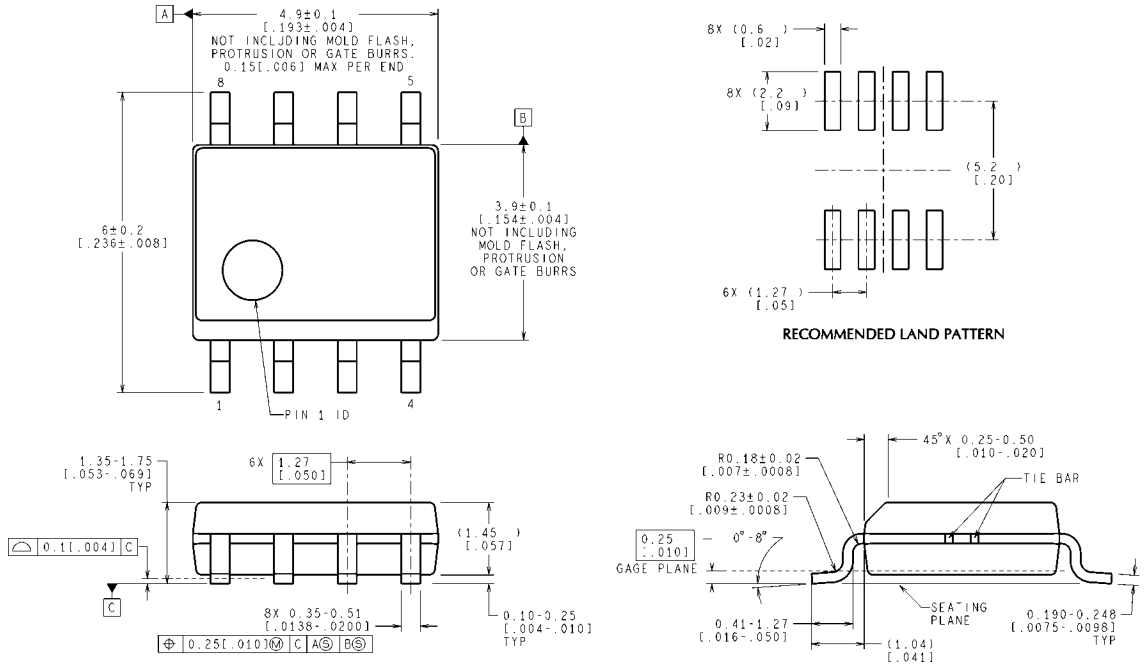

CONTROLLING DIMENSION IS MILLIMETER
 VALUES IN [] ARE INCHES
 DIMENSIONS IN () FOR REFERENCE ONLY
8-Pin SOIC
NS Product Number M08A

M08A (Rev M)

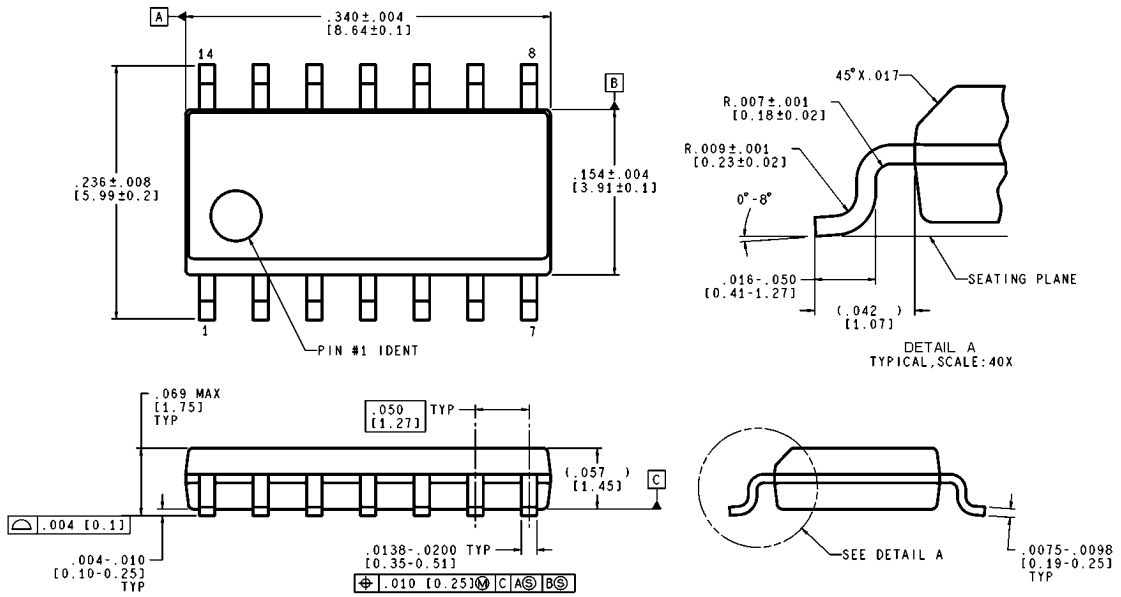

CONTROLLING DIMENSION IS INCH
 VALUES IN [] ARE MILLIMETERS

14-Pin SOIC
NS Product Number M14A

M14A (Rev J)

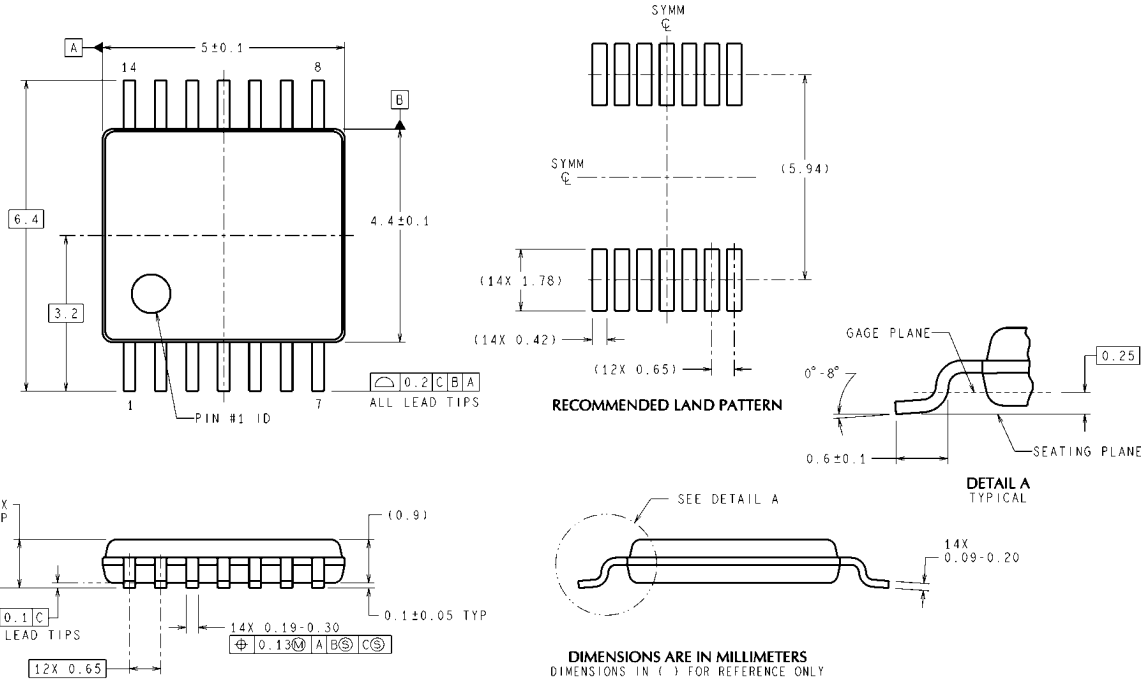

14-Pin TSSOP
NS Product Number MTC14

MTC14 (Rev D)

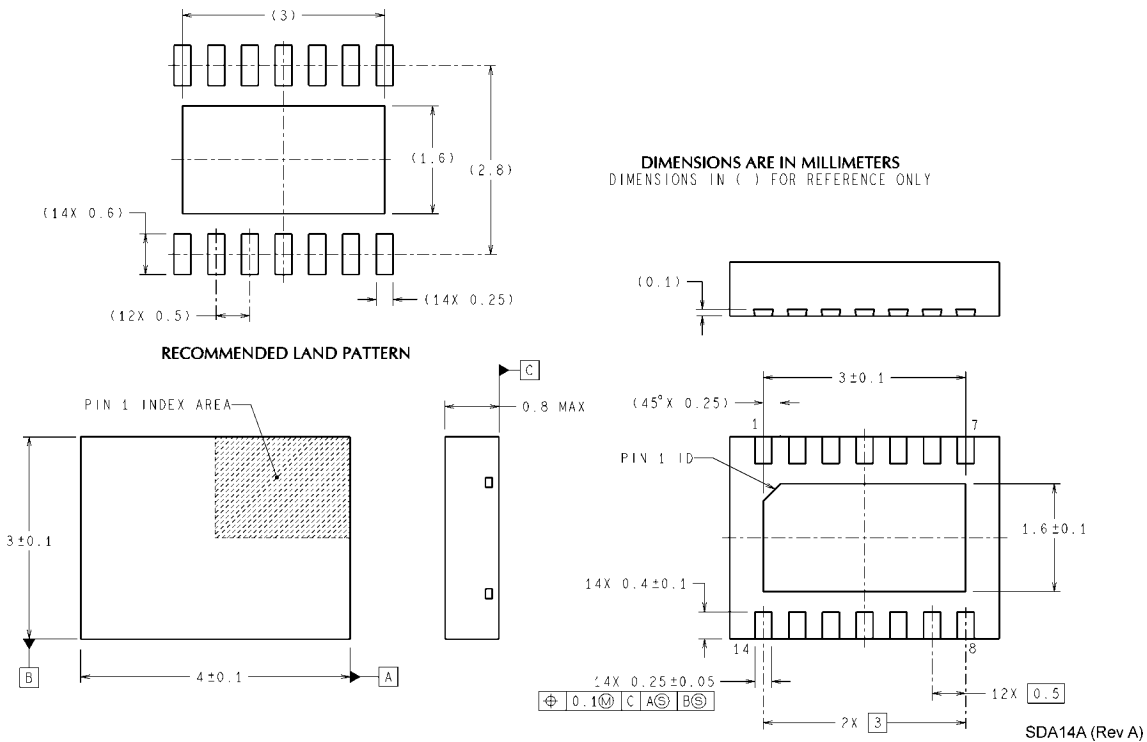

14-Pin LLP
NS Product Number SDA14A

SDA14A (Rev A)

Notes

For more National Semiconductor product information and proven design tools, visit the following Web sites at:

Products		Design Support	
Amplifiers	www.national.com/amplifiers	WEBENCH® Tools	www.national.com/webench
Audio	www.national.com/audio	App Notes	www.national.com/appnotes
Clock and Timing	www.national.com/timing	Reference Designs	www.national.com/refdesigns
Data Converters	www.national.com/adc	Samples	www.national.com/samples
Interface	www.national.com/interface	Eval Boards	www.national.com/evalboards
LVDS	www.national.com/lvds	Packaging	www.national.com/packaging
Power Management	www.national.com/power	Green Compliance	www.national.com/quality/green
Switching Regulators	www.national.com/switchers	Distributors	www.national.com/contacts
LDOs	www.national.com/ldo	Quality and Reliability	www.national.com/quality
LED Lighting	www.national.com/led	Feedback/Support	www.national.com/feedback
Voltage Reference	www.national.com/vref	Design Made Easy	www.national.com/easy
PowerWise® Solutions	www.national.com/powerwise	Solutions	www.national.com/solutions
Serial Digital Interface (SDI)	www.national.com/sdi	Mil/Aero	www.national.com/milaero
Temperature Sensors	www.national.com/tempensors	SolarMagic™	www.national.com/solarmagic
Wireless (PLL/VCO)	www.national.com/wireless	PowerWise® Design University	www.national.com/training

THE CONTENTS OF THIS DOCUMENT ARE PROVIDED IN CONNECTION WITH NATIONAL SEMICONDUCTOR CORPORATION ("NATIONAL") PRODUCTS. NATIONAL MAKES NO REPRESENTATIONS OR WARRANTIES WITH RESPECT TO THE ACCURACY OR COMPLETENESS OF THE CONTENTS OF THIS PUBLICATION AND RESERVES THE RIGHT TO MAKE CHANGES TO SPECIFICATIONS AND PRODUCT DESCRIPTIONS AT ANY TIME WITHOUT NOTICE. NO LICENSE, WHETHER EXPRESS, IMPLIED, ARISING BY ESTOPPEL OR OTHERWISE, TO ANY INTELLECTUAL PROPERTY RIGHTS IS GRANTED BY THIS DOCUMENT.

TESTING AND OTHER QUALITY CONTROLS ARE USED TO THE EXTENT NATIONAL DEEMS NECESSARY TO SUPPORT NATIONAL'S PRODUCT WARRANTY. EXCEPT WHERE MANDATED BY GOVERNMENT REQUIREMENTS, TESTING OF ALL PARAMETERS OF EACH PRODUCT IS NOT NECESSARILY PERFORMED. NATIONAL ASSUMES NO LIABILITY FOR APPLICATIONS ASSISTANCE OR BUYER PRODUCT DESIGN. BUYERS ARE RESPONSIBLE FOR THEIR PRODUCTS AND APPLICATIONS USING NATIONAL COMPONENTS. PRIOR TO USING OR DISTRIBUTING ANY PRODUCTS THAT INCLUDE NATIONAL COMPONENTS, BUYERS SHOULD PROVIDE ADEQUATE DESIGN, TESTING AND OPERATING SAFEGUARDS.

EXCEPT AS PROVIDED IN NATIONAL'S TERMS AND CONDITIONS OF SALE FOR SUCH PRODUCTS, NATIONAL ASSUMES NO LIABILITY WHATSOEVER, AND NATIONAL DISCLAIMS ANY EXPRESS OR IMPLIED WARRANTY RELATING TO THE SALE AND/OR USE OF NATIONAL PRODUCTS INCLUDING LIABILITY OR WARRANTIES RELATING TO FITNESS FOR A PARTICULAR PURPOSE, MERCHANTABILITY, OR INFRINGEMENT OF ANY PATENT, COPYRIGHT OR OTHER INTELLECTUAL PROPERTY RIGHT.

LIFE SUPPORT POLICY

NATIONAL'S PRODUCTS ARE NOT AUTHORIZED FOR USE AS CRITICAL COMPONENTS IN LIFE SUPPORT DEVICES OR SYSTEMS WITHOUT THE EXPRESS PRIOR WRITTEN APPROVAL OF THE CHIEF EXECUTIVE OFFICER AND GENERAL COUNSEL OF NATIONAL SEMICONDUCTOR CORPORATION. As used herein:

Life support devices or systems are devices which (a) are intended for surgical implant into the body, or (b) support or sustain life and whose failure to perform when properly used in accordance with instructions for use provided in the labeling can be reasonably expected to result in a significant injury to the user. A critical component is any component in a life support device or system whose failure to perform can be reasonably expected to cause the failure of the life support device or system or to affect its safety or effectiveness.

National Semiconductor and the National Semiconductor logo are registered trademarks of National Semiconductor Corporation. All other brand or product names may be trademarks or registered trademarks of their respective holders.

Copyright© 2009 National Semiconductor Corporation

For the most current product information visit us at www.national.com



**National Semiconductor
Americas Technical
Support Center**
Email: support@nsc.com
Tel: 1-800-272-9959

**National Semiconductor Europe
Technical Support Center**
Email: europe.support@nsc.com

**National Semiconductor Asia
Pacific Technical Support Center**
Email: ap.support@nsc.com

**National Semiconductor Japan
Technical Support Center**
Email: jpn.feedback@nsc.com